



## Installation Instructions

for Teekay Pipe Couplings

Please check the following before installation to ensure that your Teekay pipe coupling works perfectly.

### 1. Handling of Teekay Couplings

- Do not drop the coupling.
- Keep the coupling clean – leave it in its packaging until you are ready to use it.
- Do not dismantle the coupling.
- Check the coupling for completeness: Check that anchor rings are present on both sides if you are using axially resistant couplings (Axilock) and if you have requested a vacuum ring, please check that it is in place.
- The screws are coated – do not apply additional lubricants!

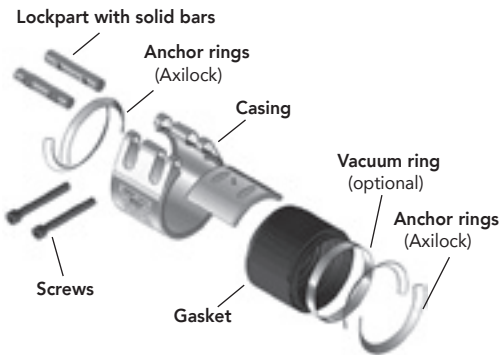

### 2. Pipe Lines

#### Pipe offset

- Make sure that the pipes are straight. The maximum acceptable pipe offset is 3 mm or 1% of the pipe diameter, whichever is smaller.

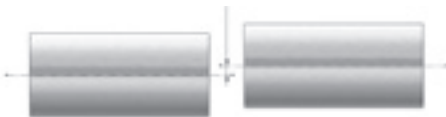

#### Test Pressure

Water is used as the testing medium for Teekay coupling pressure tests. Test pressure = 1.5 x wp. To find out about the pressure resistance when other media are used, please contact us.

### Angular Deflection

- Maximum angulation for **Axilock Couplings**

Pipe O.D. (mm)	Max. angulation
21,3 – 60,3	5°
60,3 – 219,1	4°
219,1 – 406,4	2°
406,4 – 711,2	1°

- Maximum angulation for **Axiflex Couplings**

Nominal pipe size (mm)	Coupling width (mm)	Max. angulation
40 – 100	85	5°
80 – 300	110	5°
150 – 500	140	5°
600 – 700	140	3,5°
800 – 1200	140	2°
200 – 700	210	5°
800 – 1200	210	3°



### Lateral Displacement

- Lateral displacement may be accommodated by the use of two Teekay Couplings with an intermediate length of pipe.



### Expansion

- Axilock couplings can accommodate up to **6 mm of expansion**.



- At changes of direction, any resultant angulation must not exceed 2°.

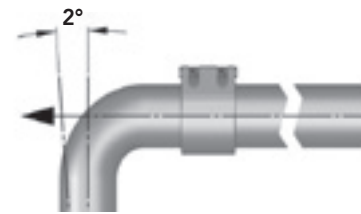

### Ovality

- Teekay Axiflex pipe couplings are sufficiently flexible to accept a misshape within the pipe cross section provided the out-of-roundness is fairly evenly distributed around the circumference (oval rather than D shaped). **Depending on application and pipe material, up to 8% ovality may be accommodated.**



### Installation

Do not exceed the limits listed in Section 2 and do not add them up. They refer to the static load on radially stiff pipes.

A safety factor must be included for dynamic loads such as water hammer, shear forces, etc. (please contact us for information).

### 3. Installation Examples

For information, please go to Pages 6 and 7.

Please observe the following instructions prior to, during and after the installation of the coupling.

### 1. Prior to Installation

- The pipe ends should be cut square and all sharp edges and burrs must be removed.
- The pipe surface must be clean and smooth with no loose material in the region of the sealing lips.
- The optimum distance between the pipe ends for Axilock couplings is 3-8mm.
- If you are working with Axiflex couplings, the distance between the pipe ends will depend on the coupling width and the use of a vacuum ring.

3 – 8 mm

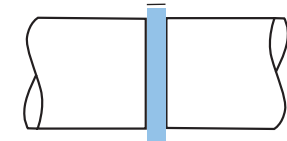

- Measure half the width of the coupling and deduct 2.5 mm. Mark the pipe ends using this dimension. This will ensure that the pipe ends will not obstruct each other and that the coupling will sit centrally over the pipe ends after installation.

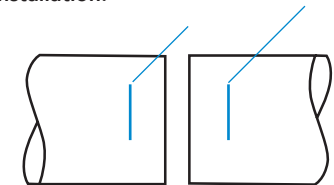

### 2. Installation of the Coupling

- Slide the coupling over the pipe and align it with the markings on the pipe ends.

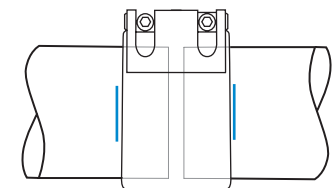

- Using a torque wrench, tighten the screws evenly, alternating from screw to screw until both "click off". **Make sure you comply with the required torque.** (See information on the label, description on Page 8.)

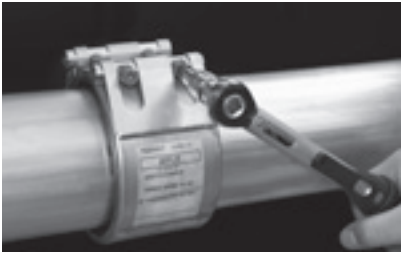

- See Section 4 (After Installation).

### Torque

The couplings do not require any maintenance and must not be re-tightened once the torque has been reached. We recommend you mark the coupling once the screws have been torqued up. This will ensure that you and others know that the screws have been tightened.

If you are unsure as to whether the screws have already been tightened, loosen the screws completely and repeat the installation from scratch.

### 3. Repair Coupling Installation

(Axiflex couplings that can be opened and wrapped around the pipe)



- Loosen the coupling screws.
- Place the opened coupling around the pipe.

### Repair coupling

Suitable also for permanent use.

- Insert the loose end of the gasket into the "tongue" located on the other side of the coupling.
- Make sure that the two **ends of the gasket are flush** against each other.



- Using a torque wrench, tighten the screws evenly, alternating from screw to screw until both "click off". **Make sure you comply with the required torque.** (See information on the label, description on Page 8.)
- For Axiflex, Repair- & Stepped Couplings > 600 mm lubricate pipe ends prior to installation.
- Use a soft mallet on the casing during tightening to ensure uniform gasket compression. See brochure page 43.



### 4. After Installation

- Check that the lockpart is parallel.



 You will find installation/dismantling videos in our mediathek [www.heco.de/mediathek](http://www.heco.de/mediathek).

## Please observe the following instructions prior to, during and after the dismantling of the coupling.

### 1. Prior to Dismantling

- Ensure that there is no pressure in the pipes at the joint to be removed.



- Protect yourself and equipment from spilling liquid.
- Make sure the pipe coupling is not supporting the pipe ends.

### 2. Dismantling the Coupling

- Loosen the screws evenly by alternating between them but do not remove completely.

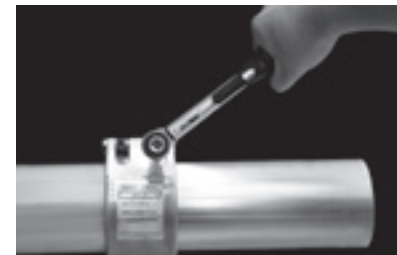

- Do not rotate the pipe coupling on the pipe as long as the anchor teeth are engaged (Axilock only).

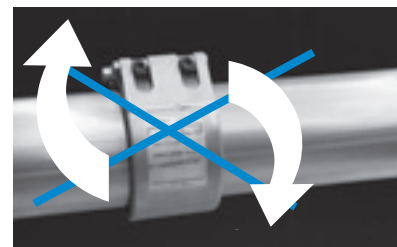

### Removal of the coupling

Slide the coupling off the pipe cautiously. Make sure that the gasket sealing lips are not damaged in the process.

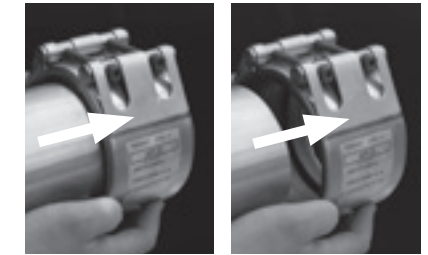

- Clean the coupling.



### Condition of the seal

If the end seal of the Axilock coupling is wholly or partially severed, you can either remove it entirely or reinsert it.

(The sole purpose of the end seal is to protect the anchor ring.)



## Guidelines for pressurised systems (side view)

### Axilock



### Axiflex

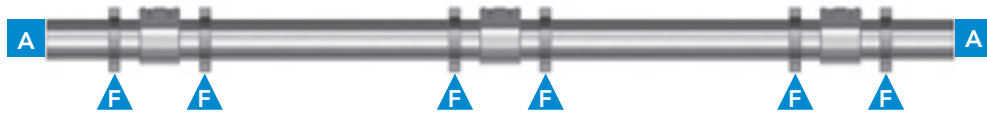

Axiflex pipe couplings are not designed to accept end load pressures. As a result, pipes must generally be anchored against internal pressure at changes in direction, branches, valves and at pipe ends and secured by fixed points and guides.

#### Shear force

Teekay pipe couplings should not be subjected to excessive shear force. The pipes should be fixed and supported.

Shear Force see Lateral Displacement (Page 2).

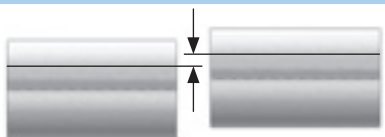

#### Straight underground pipelines

Straight underground pipelines are usually restrained by soil friction. Changes of direction have to be controlled by means of thrust blocks.



#### Loose guides

Has to be capable of accommodating the weight of the pipe including its contents e.g. a saddle or pipe support



#### Fixed point

Must absorb axial forces, e.g. anchored pipe clamp



#### Thrust block

Its purpose is to prevent pipe movement, e.g. puddle flange, wall penetration or concrete block.

## Guidelines for pressurised systems (side view)

### Axilock

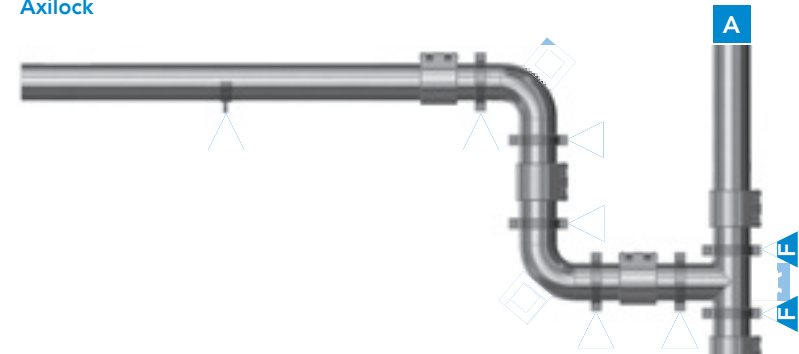

### Axiflex

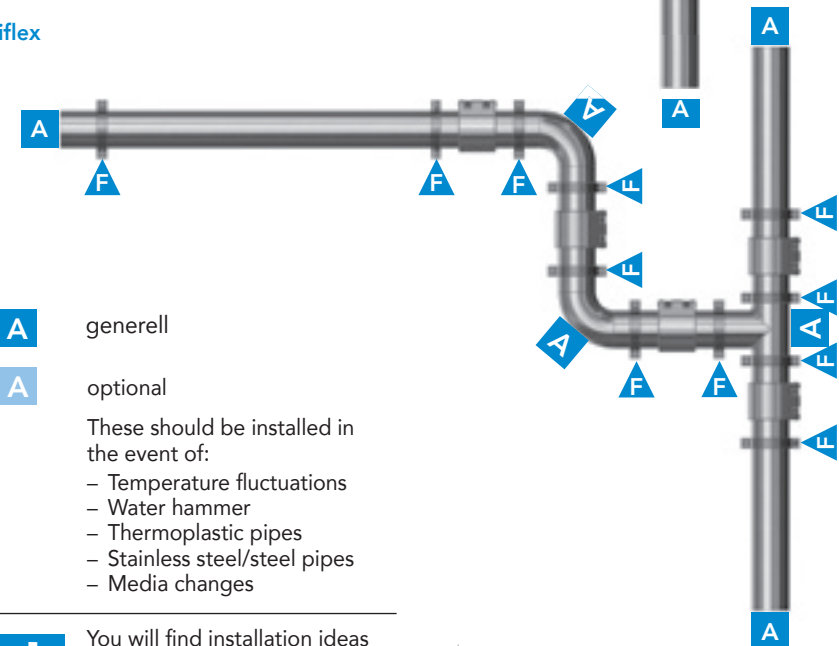

generell



optional

These should be installed in the event of:

- Temperature fluctuations
- Water hammer
- Thermoplastic pipes
- Stainless steel/steel pipes
- Media changes



You will find installation ideas for the shipbuilding industry here: [www.heco.de/schiffsbau](http://www.heco.de/schiffsbau)



If you have any installation questions, contact us 08.00 a.m.- 5.00 p.m. Mondays to Fridays:  
Service Tel. No.: +49 7232 36 55-76

#### Fixed points and guides

Please consult the industry standards for pipe supports.

## Description of an Axilock and Axiflex Coupling and of the Label

### Teekay-Axilock

(axially restrained)

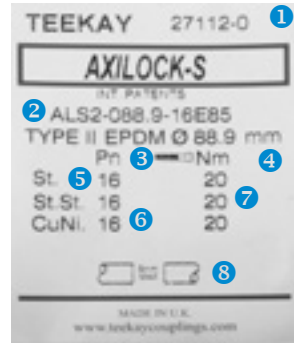
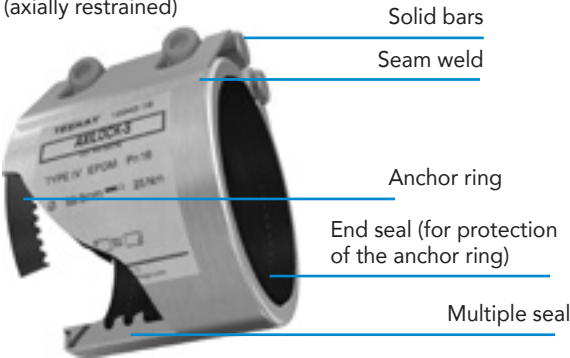

### Teekay-Axiflex

(non axially restrained)

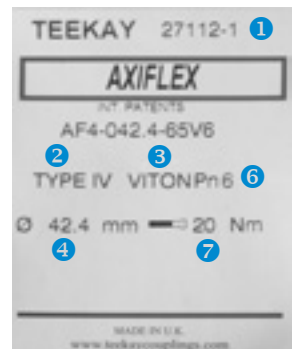
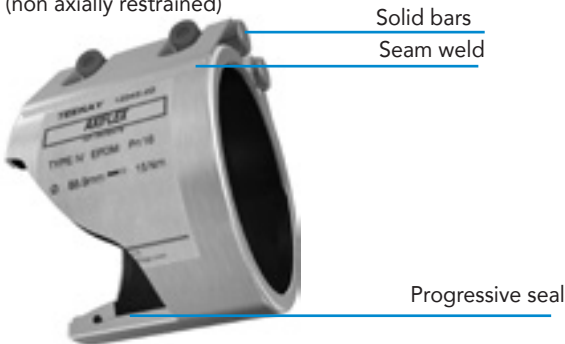

#### 1 Traceability number

Please advise when requesting documentation retrospectively.

#### 2 Description of the material

Type I = Casing 304 stainless steel  
Lockpart alloy steel PTFE coated

Type II = Casing 304 stainless steel  
Lockpart 316 stainless steel

Type IV = Casing 316L stainless steel  
Lockpart 316 stainless steel

#### 3 Gasket material

EPDM = - 40 °C to + 100 °C  
NBR = - 20 °C to + 80 °C  
HNBR = - 20 °C to + 130 °C  
Viton = - 20 °C to + 250 °C

#### 4 Pipe outside diameter

#### 5 Pipe material

St = Carbon steel  
St.St. = Stainless steel  
CuNi. = Copper nickel

#### 6 Operating pressure - Axilock

The operating pressure indicated applies to standard wall carbon steel pipes.

For stainless steel and other pipe materials, please contact us.

#### 7 Tightening torque for screws

See Page 4 (Torque)

#### 8 Maximum pipe gap

See Page 3 (Prior to Installation)